

UCS-1 Ultimate Calibration Suite

Klein Instruments Colorimeter Color Matching with Calman and JETI specbos 2501-HiRes



Device Setup



QUICK START GUIDE

Ultimate Calibration Suite

WELCOME TO CalMan® - START CALIBRATING

1 | UNBOX AND CHECK CONTENTS

Included Accessories

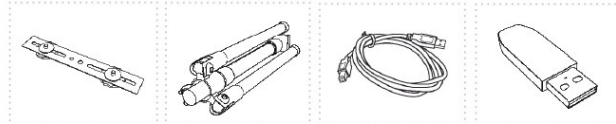

A. Mounting Bracket

B. Tripod

C. USB Cable

D. USB Drive

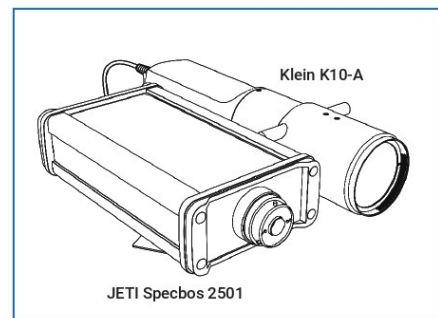

Klein K10-A

JETI Specbos 2501

2 | CONNECT

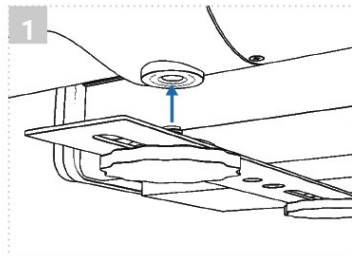

Attach Klein and Jeti units to the mounting bracket (A).

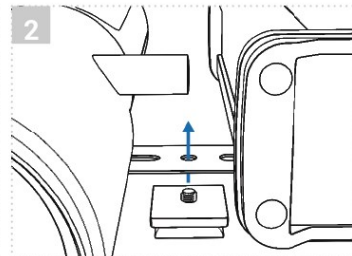

Remove baseplate from tripod (B) and attach to center of mounting bracket (C).

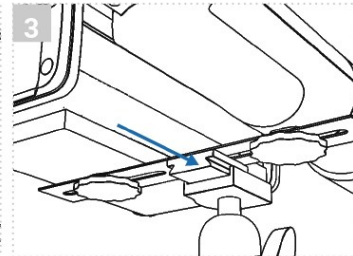

Secure baseplate onto the tripod's quick release mount.

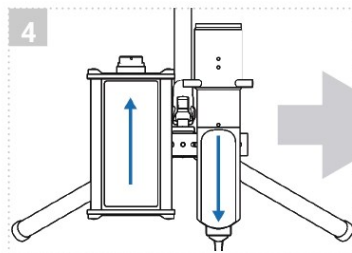

Offset the position of the units so that their front ends are parallel.

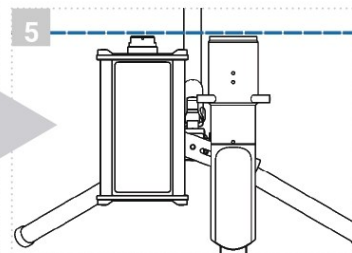

Once the front ends are at roughly the same point, tighten the knobs.

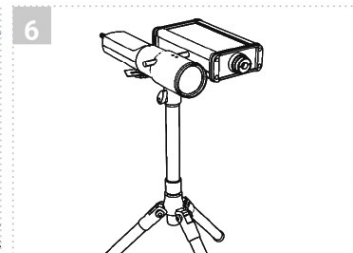

Your devices are now ready to take measurements.

Note: It may be necessary to loosen the knobs on the mounting bracket.



1. Use the laser pointer of Klein colorimeter and JETI specbos to ensure that both devices measure the display and preferably even the same spot.
2. Especially the angle of the Klein Colorimeter is large so that it might quickly measure

Calman Workflow

Profiling Steps

1. On the Calman Meter Settings tab, connect the JETI specbos 2501 and the Klein colourimeter with “Find Meter”, choosing the right device and Com Port.
(Both devices can be connected at the same time, but you have to choose the active device for subsequent measurements.)



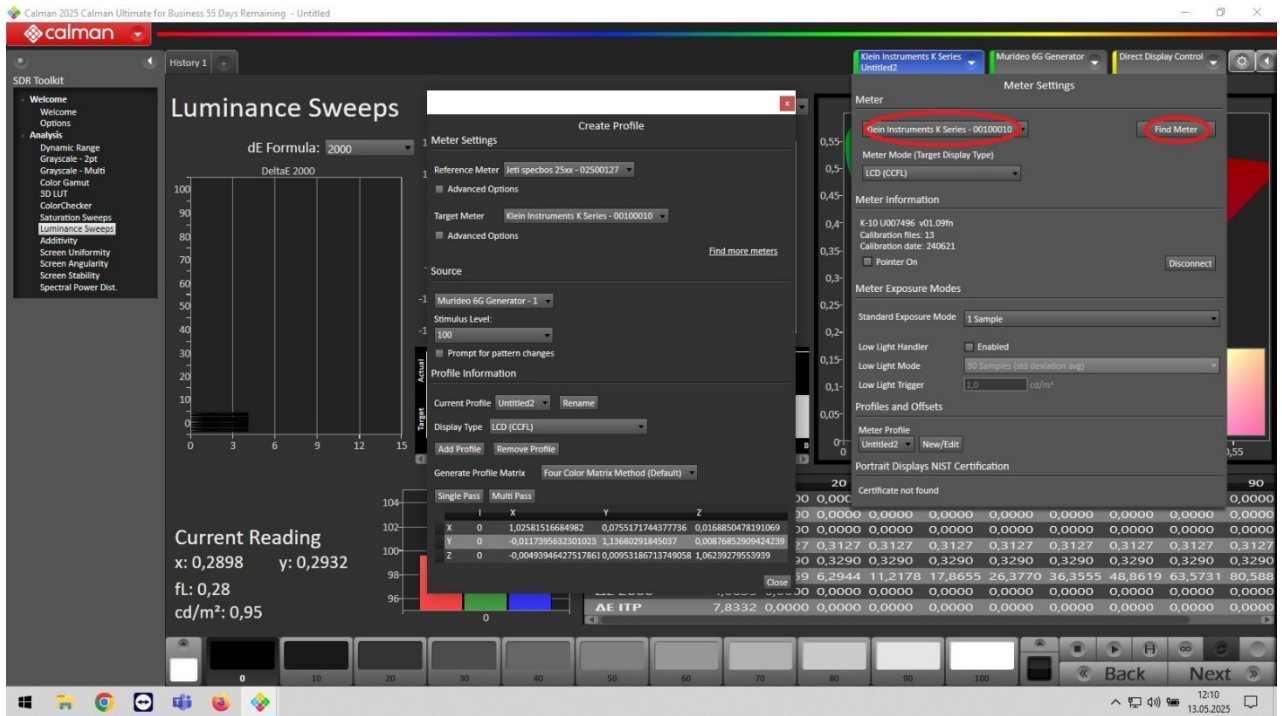

- On the Calman Meter Settings tab, the Meter Profile New/Edit button opens the Meter Profile dialog.

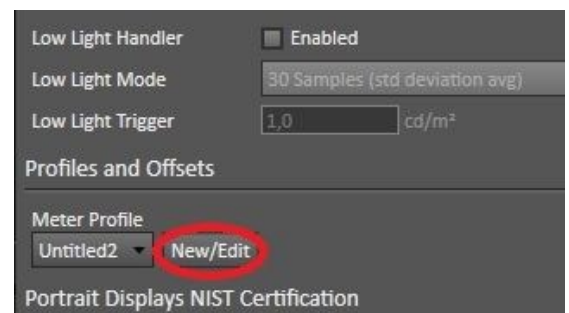
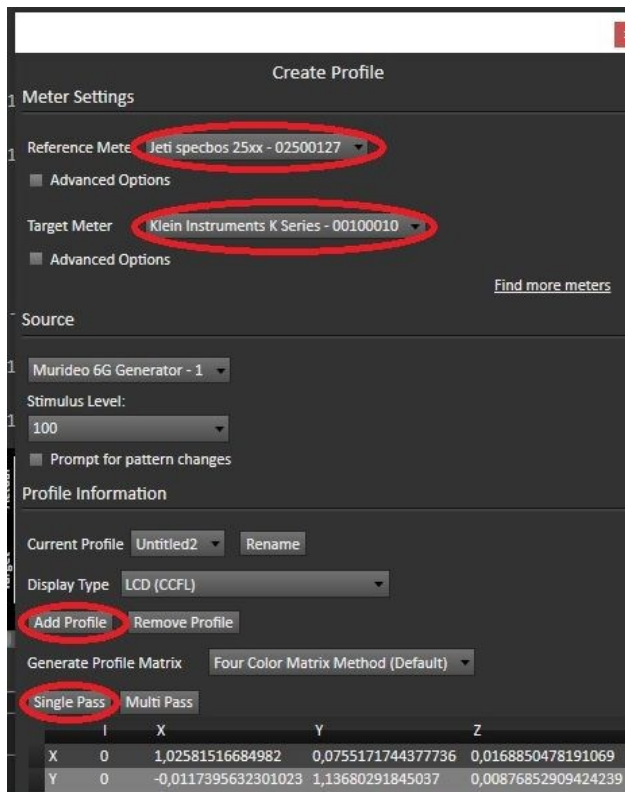

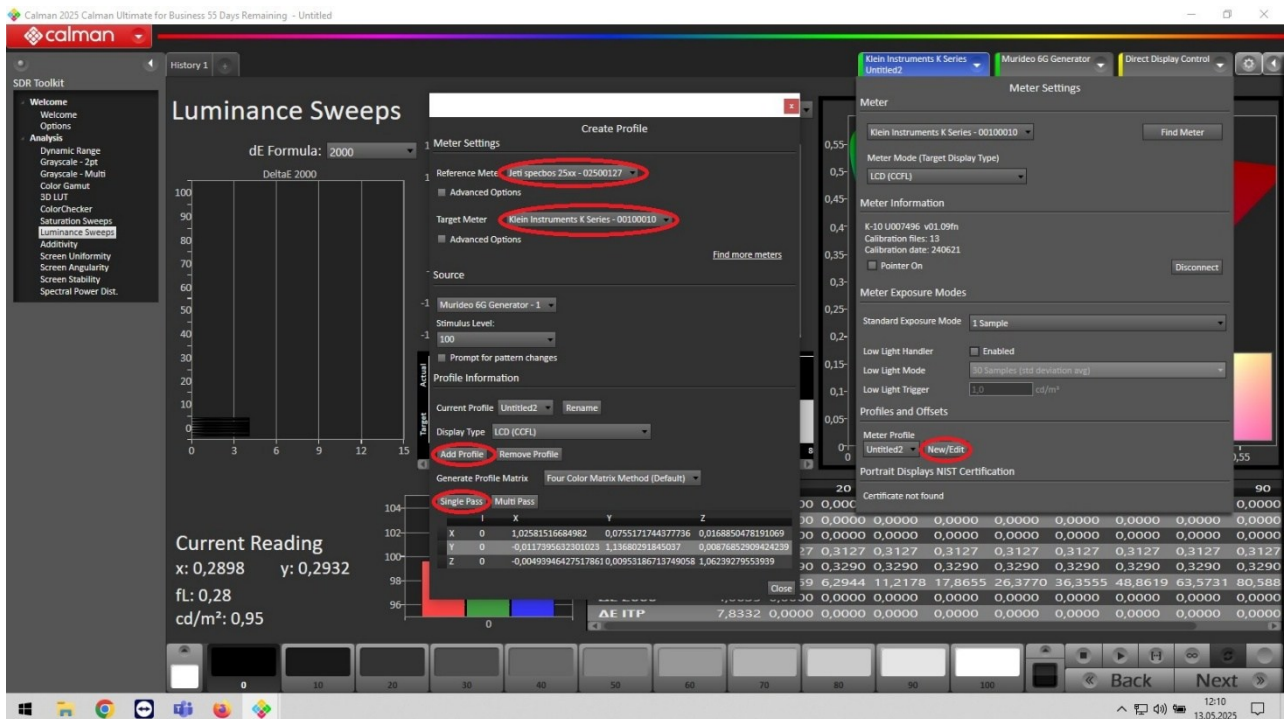

3. Choose the Jeti specbos 2501 as Reference Meter and the Klein Colourimeter as Target Meter.
4. Click the **Add Profile** button to create a new profile. Choose a name for the profile.
5. Make the measurement to generate the 4 color matrix associated with the profile:
 - Select **Single Pass** to position the two meters side-by-side at the center of the screen and Calman will automatically make measurements without moving the meters, though this is dependent on the display being very uniform across the screen.
 - Select **Multi Pass** to position first one meter then the other at a selected position on the display screen. The Calman Meter Profile process then prompts you to measure the display with both your spectrophotometer and your colorimeter. Each meter measures four colors in just seconds; white, red, green, and blue.
6. You can now choose the Klein Colourimeter as the active device and either “None” (No correction) or the name of your created profile (Jeti specbos 2501 correction). Afterwards you can make measurements.